

Sprosse og stilsprosser ses på tegning NATic_01_2 - Udadgående vinduer og fast karm - 2-lags rude.
 Glazing bar and styling bar can be seen at drawing NATic_01_2 - Outward opening windows and fixed light - 2-layer panes.

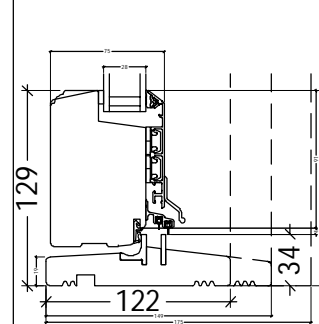

L2: NATic22-10L28

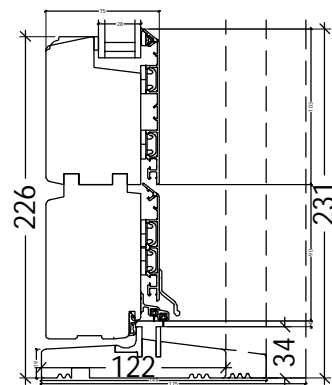

L2: NATic22-11L28

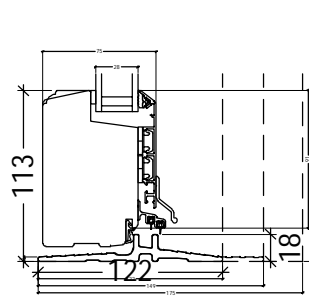

L2: NATic22-12L28

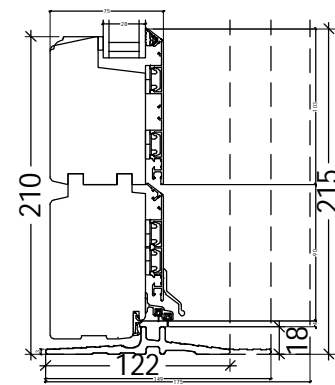

L2: NATic22-13L28

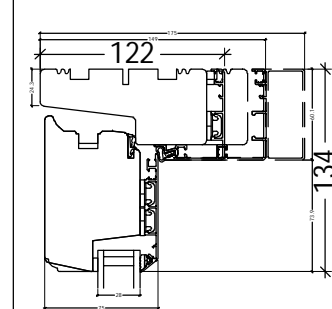

L1: NATic22-20L28

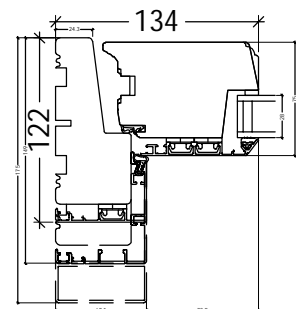

V1: NATic22-30L28
 V4/V5: NATic22-30L28(mirr.)

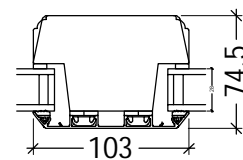

V2: NATic22-70L28

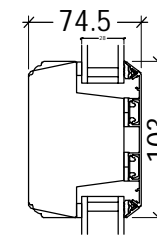

L3: NATic22-60L28

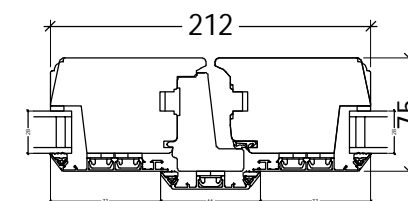

V3: NATic22-80L28

DK	Indadgående facade- og terrassedør - 2-lags rude	www.idealcombi.dk
----	--	--

UK	Inward opening entrance- and terrace door - 2-layer panes	www.idealcombi.com
----	---	--

TYPE	Nation IC	Rev. no.	02
		Drawing no.	NATic_22_2

© Idealcombi A/S 2011. This material is the property of and copyright protected by IDEALCOMBI A/S.

