

Stilsprosser ses på tegning PLU\_01\_3 - Udadgående vinduer og fast karm - 3-lags rude.  
 Styling bar can be seen at drawing PLU\_01\_3 - Outward opening windows and fixed sash - 3-layer panes.

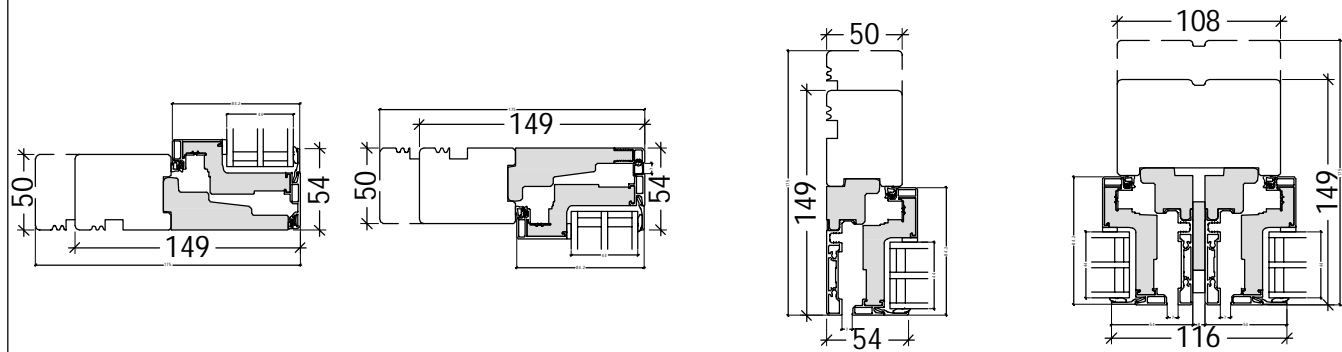

L2: PLU03-10L44

L2: PLU03-20L44

V1: PLU03-30L44  
 V3: PLU03-30L44 (mirr.)

V2: PLU03-50L44

DK Vendbart vindue - 3-lags rude

[www.idealcombi.dk](http://www.idealcombi.dk)

UK Top swing reversible window - 3-layer glazing

[www.idealcombi.com](http://www.idealcombi.com)

TYPE Futura+

Rev. no. 00

Drawing no. PLU\_03\_3

© Idealcombi A/S 2011. This material is the property of and copyright protected by IDEALCOMBI A/S.

**idealcombi**  
 Udvikler vinduet